

READ AND FOLLOW ALL SAFETY INSTRUCTIONS

IMPORTANT SAFEGUARDS

- This equipment is designed for use with germicidal UV radiation sources and must be installed in compliance with competent technical directions to prevent risk of personal injury from UV radiation.
- THESE DEVICES ARE NOT INTENDED FOR GENERAL-PURPOSE ILLUMINATION. They are assigned a Risk Group classification based on the intensity and wavelength of the radiant energy or light they produce. UV radiation can pose a risk of personal injury. Overexposure can result in damage to eyes and bare skin. To reduce the risk of overexposure, this equipment must be installed in accordance with the manufacturer's site planning recommendations.
- THESE EMITTER DEVICES ARE NOT STANDALONE DEVICES. They are intended for use only as part of germicidal systems. Consult the safety instructions of the germicidal system to confirm compatibility.
- IT IS THE RESPONSIBILITY OF THE INSTALLER TO ENSURE THAT PERSONS WILL NOT BE EXPOSED TO EXCESSIVE UV OR OPTICAL RADIATION DURING EQUIPMENT OPERATION. THIS WILL REQUIRE THE INSTALLER TO CONDUCT AN ASSESSMENT OF ALL SITE AND EQUIPMENT SAFEGUARDS TO ENSURE THE SYSTEM IS OPERATING IN ACCORDANCE WITH THE SYSTEM MANUFACTURER'S INSTRUCTIONS.
- Equipment should be mounted in locations and at heights where it will not readily be subjected to tampering by unauthorized personnel.
- Maintenance and servicing of this UV generating equipment shall be performed by authorized personnel. Service personnel must wear appropriate Personal Protective Equipment (PPE) if the equipment will be in operation during the maintenance or servicing work. Contact the equipment manufacturer for PPE recommendations and guidance.
- When replacing lamps, replace them only with the lamps for which the equipment is marked and intended.
- The use of accessory equipment not recommended by the manufacturer may cause an unsafe condition
- Do not use this equipment for anything other than the intended use.

1. CAUTION - RISK OF PERSONAL INJURY
2. THIS EQUIPMENT IS DESIGNED FOR USE WITH GERMICIDAL LAMPS OR UV SOURCES. STRICT ADHERENCE TO THE INSTALLATION DIRECTIONS IS NECESSARY TO PREVENT OCCUPANY EYE AND SKIN EXPOSURE TO HARMFUL RADIATION
3. DO NOT INSTALL THIS EQUIPMENT IN A DWELLING
4. THESE EMITTER ASSEMBLIES ARE NOT STANDALONE DEVICES. Consult safety instructions of the germicidal system to confirm compatibility.
5. WARNING - RISK OF PERSONAL INJURY
6. EYE DAMAGE MAY RESULT FROM DIRECTLY VIEWING THE LIGHT PRODUCED BY THE LAMP IN THIS EQUIPMENT. ALWAYS TURN OFF THE LAMP BEFORE SERVICING
7. USE ONLY THE LAMP TYPES PROVIDED WITH THIS PRODUCT



SAVE THESE INSTRUCTIONS

GCD SAFETY AND HANDLING INSTRUCTIONS



Imminently hazardous situation that can result in death or injury



Electrical hazard



Ultraviolet hazard





Potentially hazardous situation, minor injuries possible

- These products can be **hazardous if handled or installed incorrectly**. Ultraviolet rays can cause skin burns and eye irritation. Read and heed all safety warnings on instructions, spec sheets, cartons and fixtures. Do not install these products in any way other than what is specified on the installation sheet. This product is intended for **wall mounting only**. Always wear eye protection and gloves when handling these products and lamps. 





- These products are for indoor use only. 

- This product is to be used in **unoccupied spaces only**. Direct or reflected UVC can damage eyes and skin. It is up to the user of this product to ensure that it is used properly and safely. Anyone who performs maintenance on the fixture, or works in the space where the fixture is mounted, must be briefed on how this product works and all the safety precautions that must be observed. 

- Ensure that the space is secured before this product is energized. Be sure all doors or windows are closed so UVC will not irradiate out of the space, and that all humans or animals have left the room. 

- Beware that other objects in the room (other light fixtures, exit/emergency lighting, signage, ceiling tiles, etc.) may degrade over time if exposed to UVC light if these items are not constructed of UV-resistant material. Please shield all plants in the UVC irradiation zone from exposure as UVC can be damaging to plants. Direct exposure to rubber, plastic and other non-metals can cause degradation or color fade over time, so take precaution and shield any materials that could be affected. 

- Do not mount under or near sources of moisture – air conditioners, humidifiers, etc. 

- Please ensure that there is no power to the luminaire if you are in the process of installing, replacing lamps, or performing maintenance on the unit. Do not energize unit until it is fully installed, and the space is unoccupied. 

- Do not power on the unit if it is not properly grounded. Power requirements must match what's listed on the product date label. 

- Do not alter these products in any way, or remove any safety or warning labels. If labels become illegible over time, contact the factory for new ones. 

- UVC lamps used in these products contain mercury. Please use caution and properly dispose of any burnt-out lamps in accordance with local regulations. In the unlikely event of lamp breakage, make sure to ventilate the room, and remove the parts. Make sure not to use a vacuum cleaner to collect shards. Be careful while handling glass parts. 

- This product should only be installed by a licensed electrician in compliance with all local, national and state codes. 

- If you must enter the room while it is energized (though this not recommended), you must wear personal protection equipment when entering the space (gloves, long sleeves with no exposed skin, eye protection and a UV-resistant shield for your face 

- Do not mount this fixture in any fashion other than what is recommended. 

- Installation and servicing should be performed by qualified personnel

- These instructions are for GCD 4 1 36 GUVT8 UNV ZODS - Manufactured by LumenFocus, 880 Facet Road, Henderson, NC 27537. Phone: (252) 430-6970. Website: www.lumenfocus.com. Contact: uvfocus@lumenfocus.com

SAVE THESE INSTRUCTIONS

RADIOMETRIC DATA

GCD 4 1 36 GUVT8 UNV

Test No.: LLIA001321-001

UV-C Watts per Lamp: 14,415 mW (15,500 mW with 0.93 BF)

Luminaire UV-C Watts: 11,757 mW

Total Luminaire Efficiency: 91.6%

Luminaire Input Watts: 41.6W

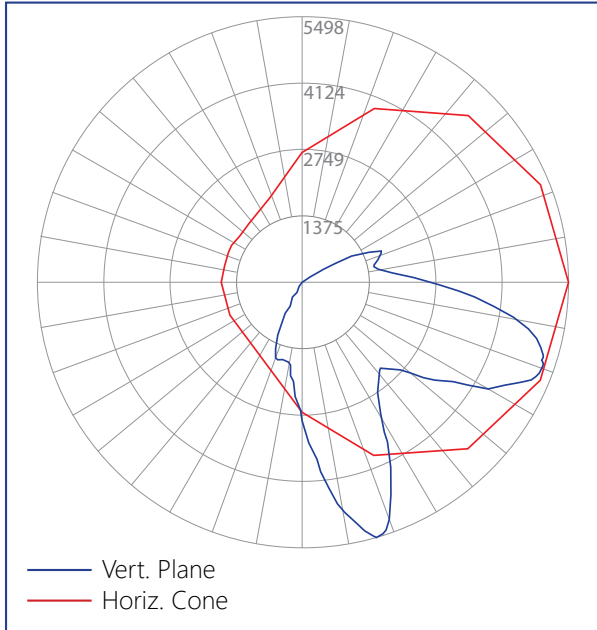

LUMENFOCUS GCD INSTALL

CAUTION: DO NOT MAKE OR ALTER ANY OPEN HOLES IN THE ENCLOSURE DURING INSTALL.

WARNING - UV EXPOSURE RISK. USE OF PROPER PROTECTIVE GEAR REQUIRED WHEN POWERING ON

WARNING - READ AND HEED ALL SAFETY WARNINGS ON INSTRUCTIONS, SPEC SHEETS, CARTONS AND LABELS.

WARNING - RISK OF FIRE OR ELECTRIC SHOCK. GCD UV FIXTURE INSTALLATION REQUIRES KNOWLEDGE OF LUMINAIRE ELECTRICAL SYSTEMS. IF NOT QUALIFIED DO NOT ATTEMPT INSTALLATION. CONTACT A QUALIFIED ELECTRICIAN.

GCD PREP FOR INSTALL

1. REMOVE SCREWS FROM THE WIRE GUARD
2. OPEN WIRE GUARD
3. REMOVE QUARTER TURNS FROM REFLECTOR
4. REMOVE REFLECTOR

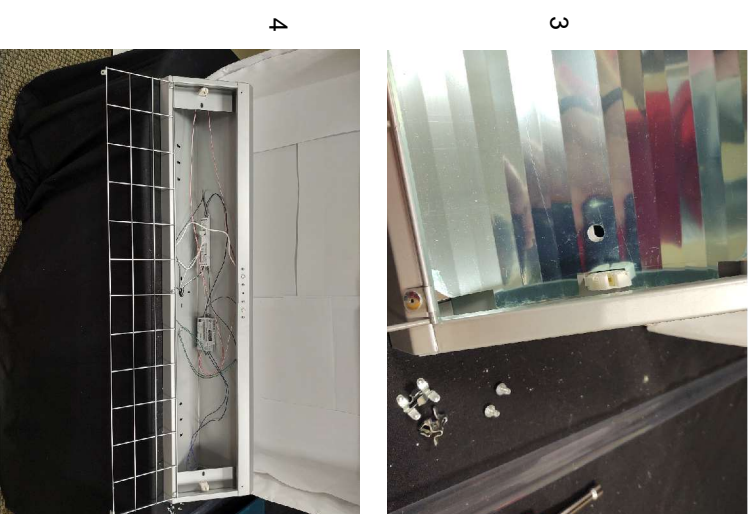

LUMENFOCUS GCD INSTALL

GCD AFTER WIRING AND INSTALL FIXTURE

1. INSTALL MOUNTING SCREWS ON 32" CENTERS
2. MOUNT HOUSING AND SECURE TO WALL
3. WITH JUNCTION BOX IN THE CENTER HOLE
4. WIRE FIXTURE PER THE SCHEMATIC

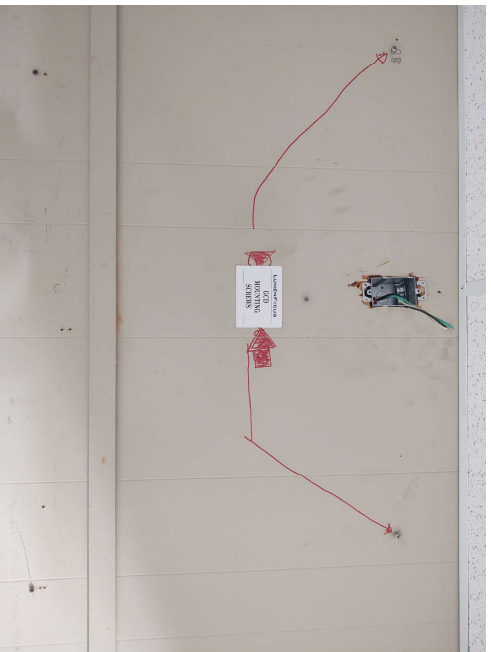

1



3
4



2

USE ONE OF THREE SETS TO MOUNT GCD TO THE WALL MOUNT IT SO THE JUNCTION BOX IS IN CENTER HOLE

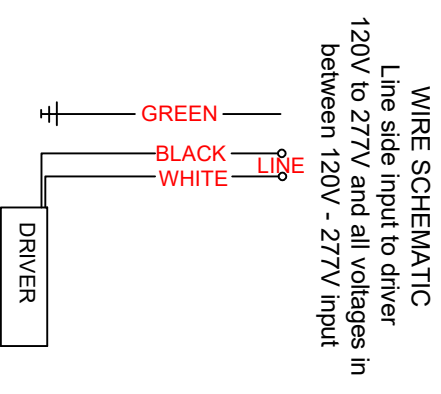

WHEN INSTALLING GCD MAINTAIN GROUND ON THE FIXTURE

LUMENFOCUS GCD INSTALL

GCD AFTER WIRING AND INSTALL FIXTURE

1. INSTALL REFLECTOR WITH A QUARTER TURN
2. PEEL FILM OFF REFLECTOR
3. INSTALL LAST QUARTER TURN
4. INSTALL UV T8 LAMP
5. CLOSE WIRE GUARD

