



Project: _____
 Location: _____
 Cat. #: _____
 Type: _____
 Quantity: _____

LED

PBL G2 HD-4W | Premium LED Heavy Duty High Bay

Features:

- High performance LED technology
- 0-10V dimming drivers standard on all models - dimmable to <10% on all models, with most dimmable to 1%
- DALI drivers available based on configuration
- Field replaceable LED boards and drivers through Re-boardABILITY (more info on Page 3)
- Frosted diffusers available to help minimize glare and improve aesthetics
- A wide variety of lumen packages allows for flexibility in design and helps maximize energy savings
- Multiple controls options available
- The PBL G2's unibody design is surface mountable with easy access to the driver compartment from below

Applications:

Suitable for most commercial, industrial and institutional applications

- Gymnasiums
- Recreation Centers
- Manufacturing
- Warehouse
- Cold/Frozen Storage *(cold temperature rules apply. Refer to warranty document at www.lumenfocus.com/support for details)*

Ambient Operating Temp.:

- -30°C to 50°C for LW, MD, HI outputs
- -30°C to 40°C for VH output

Construction:

- Housing is precision brake formed from heavy duty 0.063" aluminum
- Pre-painted with a highly durable, highly reflective white finish

Certifications:

- UL 1598 listed for US and Canada, suitable for damp locations
- DesignLights Consortium qualified on specific configurations (refer to DLC qualified products list for exact model numbers) <http://designlights.org/>



Predicted Lifetime:

- L70: 169,000 hrs (calculated)
- L80: 104,000 hrs (calculated)
- L90: 47,000 hrs (reported)
- 86% lumen maintenance @ 72,000 hrs *(based on LM-80, TM-21 and in-situ laboratory testing)*

Warranty:

- 5 year limited system warranty -see www.LumenFocus.com for complete warranty terms and conditions
- 10 year warranty option available on specific models *(Not available on all models. Certain conditions apply. Consult factory or sales representative for details)*



Ordering Guide:

example: PBL G2 4W HI HE UV 850 HDW QC20 ZOSD C6

Series	Length	Output	Performance	Voltage	Shielding	CRI/CCT	Gauge	Hanging	Controls	Options	Finish
PBL G2	4W						HDW				
PBL G2 Gen 2 Premium High Bay	4W 4'	LW Low	Blank Standard	UV 120-277	Blank No Lenses	835 80 CRI/3500K	HDW Heavy Duty 0.063" Aluminum Wide-Body Housing	Blank None	Blank No Controls	Blank No Options	Blank White
		MD Medium	HE High Efficiency (Not available in VH model)	34 347V	FR Frosted Acrylic Diffusers	840 80 CRI/4000K		QC 10' Quick Hang Cable Kit	ZOS Occupancy Sensor (On/Off)	EXT10 10-Year Extended Warranty ⁽⁶⁾	BK Matte Black
		HI High		48 480V		850 80 CRI/5000K		QC20 20' Quick Hang Cable Kit	ZOSD Occupancy Sensor (On/Off/Dim)	C6 6' Single Circuit Cord	SL Metallic Silver
		VH Very High	Blank Standard					PMS Pendant Mount with Stabilizer	ZOFD1 Leviton Bluetooth-enabled Programmable Dimming/ Occupancy/Daylight Harvesting Sensor with Grouping (120-277V) ⁽¹⁾	C65W 6' Single Circuit Cord with Low Voltage Connections	
								ST(x) 3/4" Stem (Specify Length)	ZOFDU Leviton Bluetooth-enabled Programmable Dimming/ Occupancy/Daylight Harvesting Sensor with Grouping, Scheduling (120-480V) ⁽¹⁾	C10 10' Single Circuit Cord	
									Z221BL_ Wattstopper Programmable Photo/Motion Multi-Voltage Sensor (high/low/off) ⁽²⁾	C105W 10' Single Circuit Cord with Low Voltage Connections	
									Z321BL_ Wattstopper Bluetooth- enabled Programmable Dimming/Occupancy/ Daylight Harvesting Multi-Voltage Sensor ⁽²⁾	D6 6' Dual Circuit Cord	
									ZOSMHB Leviton High Bay Microwave 0-10V Multi-Level Occupancy Sensor with Photocell ⁽³⁾	D10 10' Dual Circuit Cord	
									ZPC Photocell	P(NEMA) Plug (Specify NEMA configuration)	
									ZFMS Douglas FMS Sensor with Dimming/Occupancy/ Daylight Harvesting with Network Capabilities ⁽⁴⁾	SC Safety Cable	
									ZENLO Enlighted Ruggedized Sensor with Dimming/Occupancy/ Daylight Harvesting and Enlighted One System ⁽⁵⁾	F Fuse	
									ZENLC Enlighted Ruggedized Sensor with Dimming/Occupancy/ Daylight Harvesting and Enlighted Connected System ⁽⁵⁾	EM2 Emergency Pack ⁽⁷⁾	
									ZENLI Enlighted Ruggedized Sensor with Dimming/Occupancy/ Daylight Harvesting and Enlighted IoT System ⁽⁵⁾	SDT(480V) 480V to 277V Step Down Transformer	
										CC Conformal Coating	
										LVL 0-10V Dimming Leads for Easy Field Access	
										BAA Buy American Act Compliant	

Notes

- ⁽¹⁾ For 8' to 40' mounting heights. See Page 5 for more details.
- ⁽²⁾ " " = lens type. See Page 5 for lens descriptions.
- ⁽³⁾ Max ceiling height is 50 feet. See page 5 for more details.
- ⁽⁴⁾ Max ceiling height for Douglas FMS sensor: 40 feet. See Page 6 for more details on advanced controls.
- ⁽⁵⁾ Max ceiling height for Enlighted Ruggedized sensor 50 feet. See Page 6 for more details on advanced controls.
- ⁽⁶⁾ Not available on all models. Certain conditions apply. Consult factory or sales representative for details.
- ⁽⁷⁾ EM2 - Up to 16W. 120-277V / 0°C-50°C ambient.

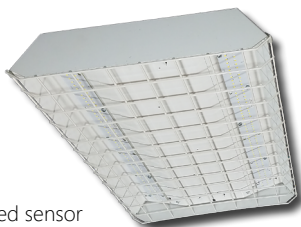

Accessories (order separately)

- WG(PBL4W) Wire Guard
- WGE(PBL4W) Extended Wire Guard for use with end-mounted sensor

Controls Accessories (order separately)

- For Douglas Controls**
 - BT-DMSW-U-A Bluetooth 1 Zone Dimmer
 - BT-4BTSW-U-A Bluetooth 4-Button Wall Station
 - BT-8BTSW-U-A Bluetooth 8-Button Wall Station

- For Enlighted Controls**
 - WS-2-00 Enlighted Remote Control Wall Switch (for Enlighted Connected & IoT)
 - WS-2-00-IL Enlighted Remote Control Wall Switch (for Enlighted One)

- For Z221BL_ Sensor**
 - FSIR-100 Wireless Configuration Tool

- For ZOSMHB Sensor**
 - ZLSOR Wireless Configuration Tool



Performance Chart:

Catalog #	Lumens	Watts	LPW	Catalog #	Lumens	Watts	LPW	Catalog #	Lumens	Watts	LPW
PBL G2 4W LW HE UV 835	31232	181	172.8	PBL G2 4W LW HE UV 840	32352	181	179.0	PBL G2 4W LW HE UV 850	32352	181	179.0
PBL G2 4W MD HE UV 835	35088	205	170.9	PBL G2 4W MD HE UV 840	36346	205	177.0	PBL G2 4W MD HE UV 850	36346	205	177.0
PBL G2 4W HI HE UV 835	38922	235	166.0	PBL G2 4W HI HE UV 840	40317	235	171.9	PBL G2 4W HI HE UV 850	40317	235	171.9
PBL G2 4W LW UV 835	31480	187	168.0	PBL G2 4W LW UV 840	32609	187	174.0	PBL G2 4W LW UV 850	32609	187	174.0
PBL G2 4W MD UV 835	35346	215	164.3	PBL G2 4W MD UV 840	36613	215	170.2	PBL G2 4W MD UV 850	36613	215	170.2
PBL G2 4W HI UV 835	39908	245	163.1	PBL G2 4W HI UV 840	41339	245	168.9	PBL G2 4W HI UV 850	41339	245	168.9
PBL G2 4W VH UV 835	51939	320	162.5	PBL G2 4W VH UV 840	53801	320	168.4	PBL G2 4W VH UV 850	53801	320	168.4
PBL G2 4W LW HE UV FR 835	29361	181	162.5	PBL G2 4W LW HE UV FR 840	30413	181	168.3	PBL G2 4W LW HE UV FR 850	30413	181	168.3
PBL G2 4W MD HE UV FR 835	32986	205	160.7	PBL G2 4W MD HE UV FR 840	34168	205	166.4	PBL G2 4W MD HE UV FR 850	34168	205	166.4
PBL G2 4W HI HE UV FR 835	36590	235	156.0	PBL G2 4W HI HE UV FR 840	37902	235	161.6	PBL G2 4W HI HE UV FR 850	37902	235	161.6
PBL G2 4W LW UV FR 835	29594	187	157.9	PBL G2 4W LW UV FR 840	30655	187	163.6	PBL G2 4W LW UV FR 850	30655	187	163.6
PBL G2 4W MD UV FR 835	33228	215	154.5	PBL G2 4W MD UV FR 840	34419	215	160.0	PBL G2 4W MD UV FR 850	34419	215	160.0
PBL G2 4W HI UV FR 835	37643	245	154.0	PBL G2 4W HI UV FR 840	38992	245	159.5	PBL G2 4W HI UV FR 850	38992	245	159.5
PBL G2 4W VH UV FR 835	48897	320	153.0	PBL G2 4W VH UV FR 840	50649	320	158.5	PBL G2 4W VH UV FR 850	50649	320	158.5

Lumen Adjustment Factors: WG: 0.95

Schematic:

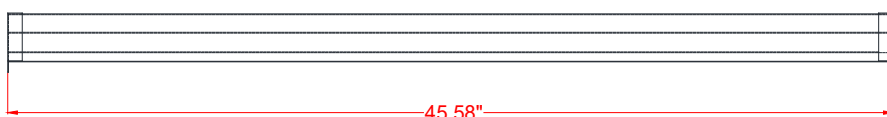
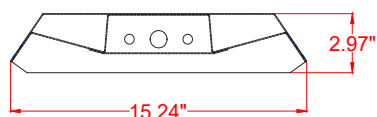

LUMENFOCUS
Re-boardABILITY

The PBL G2 HD features field replaceable boards and drivers. This allows you to upgrade to more efficient technology in the future. Or, in the rare event of a failure, you can rapidly replace defective components. Re-boardABILITY helps to ensure you won't get stuck with an obsolete light fixture. [Learn more about Re-boardABILITY here.](#)

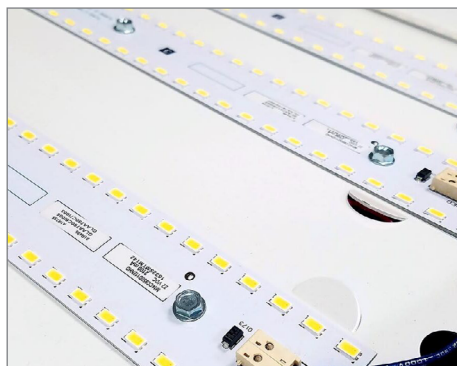

[Click here for a video demonstration of the re-boarding process on a PBL.](#)

Note: Exact time varies depending on the model.



Photometric Data:

PBL G2 4W HI UV 835

Test No.: LLIA001249-018
 Luminaire Lumens: 39,908 lm
 Luminaire Watts: 244.7W
 Efficacy: 163.1 LPW
 Spacing Criterion (0-180): 1.30
 Spacing Criterion (90-270): 1.28

Luminance Data (cd/sq.m)			
Angle In Degrees	Average 0-Deg	Average 45-Deg	Average 90-Deg
45	30593	30291	30442
55	29761	29618	29966
65	27711	28055	28978
75	23282	25736	19846
85	11896	7965	8772

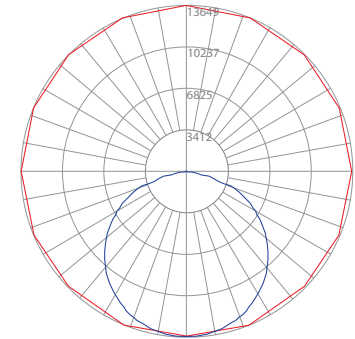

— Vert. Plane
 — Horiz. Cone

Zonal Lumen Summary

Zone	Lumens	%Fixt
0-20	4981.0	12.5
0-30	10638.8	26.7
0-40	17560.3	44.0
0-60	31554.8	79.1
0-80	39430.4	98.8
0-90	39903.4	100.0
90-120	4.9	0.0
90-130	4.9	0.0
90-150	4.9	0.0
90-180	4.9	0.0
0-180	39908.3	100.0

Coefficients Of Utilization - Zonal Cavity Method
 Effective Floor Cavity Reflectance 0.20

RC	80				70				50				30			
RW	70	50	30	10	70	50	30	10	50	30	10	50	30	10		
0	119	119	119	119	116	116	116	116	111	111	111	106	106	106		
1	109	104	100	96	106	102	98	95	98	94	92	94	91	89		
2	99	91	84	78	96	89	82	77	85	80	75	82	77	74		
3	90	79	71	65	88	78	70	64	75	68	63	72	67	62		
4	82	70	61	55	80	69	61	54	66	59	53	64	58	53		
5	76	63	54	47	73	61	53	47	59	52	46	57	51	46		
6	70	56	47	41	68	55	47	41	53	46	40	52	45	40		
7	65	51	42	36	63	50	42	36	49	41	35	47	40	35		
8	60	46	38	32	58	46	38	32	44	37	32	43	36	31		
9	56	43	34	29	55	42	34	29	41	34	28	40	33	28		
10	53	39	31	26	51	39	31	26	38	31	26	37	30	26		

Tested in accordance with IES standards utilizing absolute photometry per LM-79-08

PBL G2 4W HI UV FR 835

Test No.: LLIA001249-017
 Luminaire Lumens: 37,642 lm
 Luminaire Watts: 244.5W
 Efficacy: 154.0 LPW
 Spacing Criterion (0-180): 1.26
 Spacing Criterion (90-270): 1.28

Luminance Data (cd/sq.m)			
Angle In Degrees	Average 0-Deg	Average 45-Deg	Average 90-Deg
45	26412	28093	29255
55	23080	26980	29045
65	18768	25886	29166
75	14113	25596	24202
85	9293	19679	18117

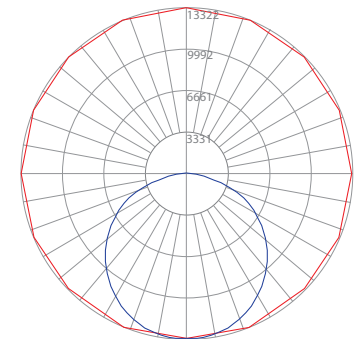

— Vert. Plane
 — Horiz. Cone

Zonal Lumen Summary

Zone	Lumens	%Fixt
0-20	4849.4	12.9
0-30	10293.6	27.3
0-40	16834.1	44.7
0-60	29545.3	78.5
0-80	36824.6	97.8
0-90	37618.5	99.9
90-120	24.0	0.1
90-130	24.0	0.1
90-150	24.0	0.1
90-180	24.0	0.1
0-180	37642.5	100.0

Coefficients Of Utilization - Zonal Cavity Method
 Effective Floor Cavity Reflectance 0.20

RC	80				70				50				30			
RW	70	50	30	10	70	50	30	10	50	30	10	50	30	10		
0	119	119	119	119	116	116	116	116	111	111	111	106	106	106		
1	109	104	99	95	106	101	98	94	97	94	91	93	91	88		
2	99	90	83	78	96	88	82	77	85	79	75	82	77	73		
3	90	79	71	64	87	78	70	64	75	68	63	72	66	62		
4	82	70	61	55	80	69	61	54	66	59	53	64	58	53		
5	76	63	54	47	74	62	53	47	59	52	46	57	51	46		
6	70	56	47	41	68	55	47	41	54	46	40	52	45	40		
7	65	51	42	36	63	50	42	36	49	41	36	47	41	35		
8	60	47	38	32	59	46	38	32	45	37	32	43	37	32		
9	56	43	35	29	55	42	34	29	41	34	29	40	33	29		
10	53	40	32	26	52	39	31	26	38	31	26	37	31	26		

Tested in accordance with IES standards utilizing absolute photometry per LM-79-08



Controls Summary:

Control Code	Type	Capabilities	Communication
ZOS	Motion (PIR)	On/Off	Wired
ZOSD	Motion (PIR), Photosensor	On/Low/Off	Wired 1-10V
ZOFD1	Motion (PIR), Daylight Harvesting	High/Low/Off, High-End Trim, Grouping	Wired 0-10V, Programmable via Bluetooth App (iOS, Android)
ZOFDU	Motion (PIR), Daylight Harvesting	High/Low/Off, High-End Trim, Grouping, Scheduling	Wired 0-10V, Programmable via Bluetooth App (iOS, Android)
Z221BLx	Motion (PIR), Photosensor	High/Low/Off, High-End Trim	Wired 0-10V, Programmable via IR remote (sold separately)
Z321BLx	Motion (PIR), Daylight Harvesting	High/Low/Off, High-End Trim	Wired 0-10V, Programmable via Bluetooth App (iOS, Android)
ZOSMHB	Motion (Microwave), Photosensor	On/Low/Off	Wired 0-10V, Programmable via ZLS0R IR remote (sold separately)
ZPC	Photosensor	On/Off	Wired
ZFMS	Motion (PIR), Daylight Harvesting	High/Low/Off, High-End Trim, Grouping, LLLC (Douglas Lighting Controls-Dialog)*	Wireless Bluetooth Mesh, Programmable via iOS App or Douglas Dialog Software
ZENLO	Motion (PIR), Daylight Harvesting	High/Low/Off, High-End Trim, Grouping, Upgradable to Connected (ZENLC) or IoT (ZENLI)	Wireless Bluetooth Low Energy Mesh, Programmable via Enlighted Room Controller WS-2-00-IL (sold separately)
ZENLC	Motion (PIR), Daylight Harvesting	High/Low/Off, High-End Trim, Grouping, Scheduling*, Energy Monitoring*, BMS Integration*, Upgradable to IoT (ZENLI), LLLC (Enlighted IoT)*	Wireless Bluetooth Low Energy Mesh, Programmable via Enlighted IoT Software
ZENLI	MoMotion (PIR), Daylight Harvesting	High/Low/Off, High-End Trim, Grouping, Scheduling*, Energy Monitoring*, BMS Integration*, LLLC (Enlighted IoT)*, Space - Building Utilization*, Where - Real Time Location Services*	Wireless Bluetooth Low Energy Mesh, Programmable via Enlighted IoT Software

LLLC = Luminaire Level Lighting Control

* Additional equipment required. Contact LumenFocus representative for details

Programmable Dimming Sensors:

ZOFDx Sensor Option

- Leviton Smart IP66 passive infrared (PIR) sensors
- Features mesh grouping (16 devices per group), occupancy sensing, daylight harvesting, scheduling (for ZOSFDU only), single-level switching
- Comes pre-installed on the end cap
- Rated for cold locations
- Configurable through the Leviton Smart Sensor App using a smartphone or other Bluetooth-enabled iOS or Android device



The ZOFD option includes four sensor lenses that can easily be installed or swapped out in the field. From left: the high bay lens (20'-40' mounting), the high bay lens with aisleway mask, the low bay lens (8'-20' mounting), and the low bay lens with aisleway mask.



FSP with L7 lens

FSIR-100

Z221B, Z321B Sensor Options

- The Wattstopper FSP sensor provides multi-level control based on motion and/or daylight contribution
- Comes pre-installed on the end cap
- Rated for cold locations
- Parameters for Bluetooth-enabled Z321B adjustable via phone app - iOS or Android
- Parameters for Z221B adjustable via wireless configuration tool (FSIR-100 - sold separately)
- Three lenses available, tailored for the ideal detection area and mounting height:
 - **L2:** 360° lens, maximum coverage 48', diameter from 8' height
 - **L3:** 360° lens, maximum coverage 40', diameter from 20' height
 - **L7:** 360° lens, maximum coverage 100', diameter from 40' height

ZOSMHB Sensor Option

- Provides occupancy detection and multi-level control with adjustable time-outs
- Tri-level dimming control
- Comes pre-installed on the end cap
- Suitable for cold storage locations
- Built-in photocell reads brightness values. Sensor does not switch luminaire on if there is sufficient ambient light
- Control parameters selected manually via DIP switches, or using the optional ZLS0R remote **ZLS0R** (sold separately) - adjustable parameters include sensitivity, hold time, lux level, stand-by light level, stand-by hold time
- Maximum mounting height of 50 feet, with adjustable coverage radius up to 30 feet



Universal Douglas: Cloud-based controls

The PBL G2 HD can be equipped with the Douglas FMS sensor, which is designed for high bay applications.

With a max sensor height up to 40 feet, the FMS is ideal for applications like warehouses and manufacturing facilities. It can be installed for on/off control or bi-level light functionality. The daylight sensor provides additional savings by dimming the lights to work with the amount of natural available daylight.

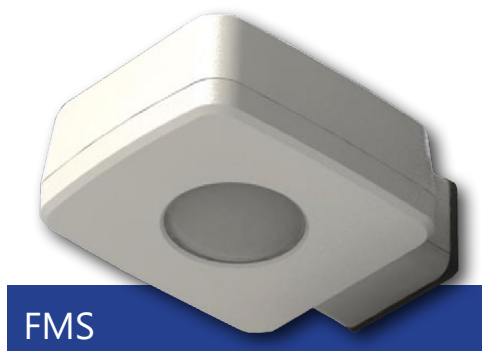

- Configuration from the floor via smartphone app
- Bluetooth mesh network is created between devices for control over a group of Douglas sensors
- Occupancy and daylight sensing
- IP65-rated
- 0-10V dimming
- 150 feet clear line of site, 50 feet through standard walls (distances may vary based on location and environment)

CheckLight® Energy Management System

Douglas controls can be integrated with the CheckLight® Energy Management system. This system can help you uncover energy conversion opportunities, create conservation strategies, analyze lighting load inefficiencies, and make configuration changes from anywhere with Douglas' user-friendly interface. You can get measurements, reports, and control your system from a web-based application.

- CheckLight® has the capability to look at different facilities within a portfolio and use data benchmarks to compare building performances.
- Find energy conservation opportunities
 - Create energy saving strategies
 - Analyze load inefficiencies
 - Optimize energy management

Enlighted: All-in-one sensors, upgradeable systems

Enlighted's IP65-rated Ruggedized Sensor is an all-in-one unit: task tuning, high-end trimming, daylight harvesting, and occupancy/vacancy detection. Max installation height is 50 feet.

Enlighted sensors come standard with the Enlighted One system (the "ZENLO" option). Enlighted Connected ("ZENLC") offers even more options. The Enlighted IoT ("ZENLI") option allows the full implementation of Enlighted's services. Each system can be fully upgraded to the next tier in the future. So if you start with Enlighted One but want to add energy reporting or building management systems integration in the future, you can.



Enlighted Capabilities*	Enlighted One (ZENLO)	Enlighted Connected (ZENLC)	Enlighted IoT (ZENLI)
Motion and Switch Groups	✓	✓	✓
Daylight Harvesting	✓	✓	✓
Schedule Lighting		✓	✓
Energy Reporting & Optimization		✓	✓
Environment Data & Lighting Controls API		✓	✓
Building Management System Integration		✓	✓
Where & Space Applications			✓
Location & Occupancy APIs & Beacons			✓
Future App & API Ready			✓

Note: Additional equipment required for ZENLC and ZENLI

Real-time data analytics

Enlighted's control units compile data in real-time, which can be viewed via the Energy Manager. The Energy Manager is part of the Enlighted Connected and Enlighted IoT configurations.

- Real-time measurements and verification of energy savings
- Space analytics - data can be compiled into motion trails and heat maps
- Analyze traffic density and congestion in a space

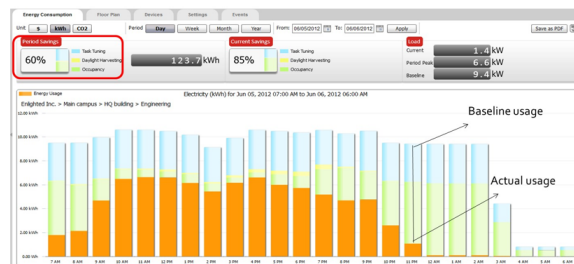

Learn more about our available advanced controls options here:
www.lumenfocus.com/controls-overview

© 2022 Enlighted for all Enlighted content and images.

© 2022 Douglas Lighting Controls, Inc. for all Douglas content and images. The Bluetooth® word, mark and logos are registered trademarks owned by the Bluetooth SIG, Inc. and any use of such marks by Douglas Lighting Controls is under license. Other trademarks and trade names are those of their respective owners.



Mounting:



Surface Mount

The PBL G2 is designed to be easily mounted to any sturdy surface. Simply remove the hex head screws holding the driver cover (top picture, in green) to access the bottom of the housing below. The housing can be mounted to the surface from the four holes in each corner of the channel (bottom picture, circled).

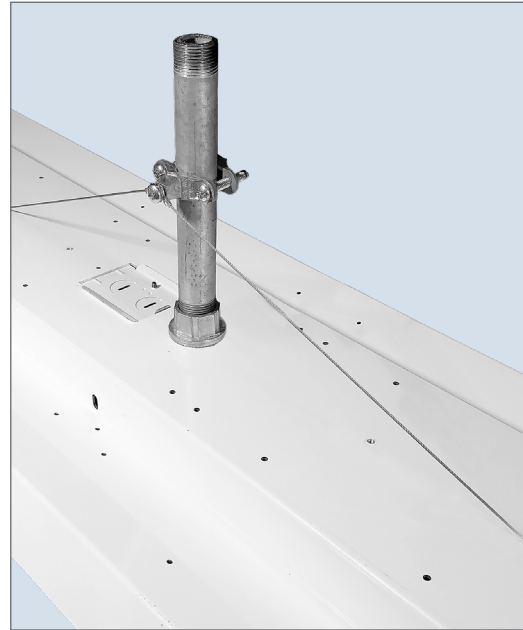

Pendant Mount The PBL G2 HD can be pendant mounted with optional 3/4" hub with stabilizer. Stem also available as an option.

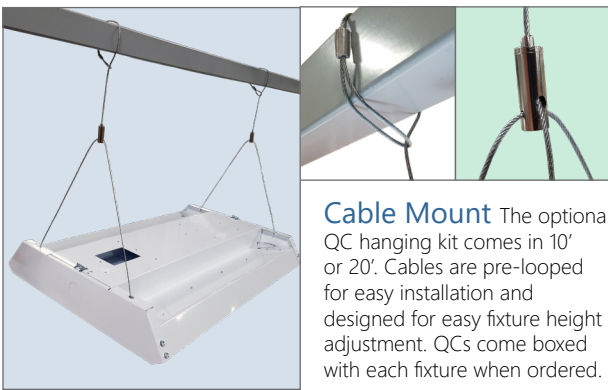

Cable Mount The optional QC hanging kit comes in 10' or 20'. Cables are pre-looped for easy installation and designed for easy fixture height adjustment. QCs come boxed with each fixture when ordered.

Other Options:

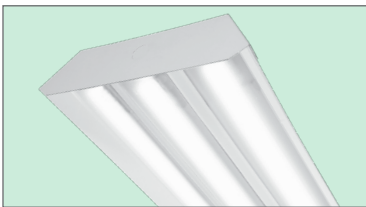

Shielding Frosted acrylic diffuser lenses minimize glare and improve aesthetics.



Cords are available in single circuit or dual circuit, 6' or 10'. Standard plug is optional, as are other NEMA configurations if specified.

Conformal coating

Grants LED boards added protection from moisture and corrosion in more hazardous environments.



Finish

In addition to the standard white finish, the PBL G2 is also available in matte black (BK) and metallic silver (SL).

